



CANEC24021252902

2024 10 09

1 12

Jany Zhong

:

		SGS ID	
SN1	A1	CAN24-0212529-0001.C001	
SN2	A2	CAN24-0212529-0001.C002	,
SN3	A3	CAN24-0212529-0001.C003	

			MDL	A1	A2	A3
(OctaBB)	-	mg/kg	25	ND	ND	ND
(NonaBB)	-	mg/kg	25	ND	ND	ND
(DecaBB)	-	mg/kg	25	ND	ND	ND
(PBDE)	1000	mg/kg	-	ND	ND	ND
(MonoBDE)	-	mg/kg	25	ND	ND	ND
(DiBDE)	-	mg/kg	25	ND	ND	ND
(TriBDE)	-	mg/kg	25	ND	ND	ND
(TetraBDE)	-	mg/kg	25	ND	ND	ND
(PentaBDE)	-	mg/kg	25	ND	ND	ND
(HexaBDE)	-	mg/kg	25	ND	ND	ND
(HeptaBDE)	-	mg/kg	25	ND	ND	ND
(OctaBDE)	-	mg/kg	25	ND	ND	ND
(NonaBDE)	-	mg/kg	25	ND	ND	ND
(DecaBDE)	-	mg/kg	25	ND	ND	ND
(2- ) (DEHP)	1000	mg/kg	50	ND	ND	ND
(BBP)	1000	mg/kg	50	ND	ND	ND
(DBP)	1000	mg/kg	50	ND	ND	ND
(DIBP)	1000	mg/kg	50	ND	ND	ND

			MDL	A4	A5	A6
(Pb)	1000	mg/kg	2	4	ND	4
(Hg)	1000	mg/kg	2	ND	ND	ND
(Cd)	100	mg/kg	2	ND	ND	ND
(Cr(VI))	1000	mg/kg	8	ND	ND	ND
(PBB)	1000	mg/kg	-	ND	ND	ND
(MonoBB)	-	mg/kg	25	ND	ND	ND
(DiBB)	-	mg/kg	25	ND	ND	ND
(TriBB)	-	mg/kg	25	ND	ND	ND
(TetraBB)	-	mg/kg	25	ND	ND	ND
(PentaBB)	-	mg/kg	25	ND	ND	ND
(HexaBB)	-	mg/kg	25	ND	ND	ND
(HeptaBB)	-	mg/kg	25	ND	ND	ND
(OctaBB)	-	mg/kg	25	ND	ND	ND
(NonaBB)	-	mg/kg	25	ND	ND	ND
(DecaBB)	-	mg/kg	25	ND	ND	ND
(PBDE)	1000	mg/kg	-	ND	ND	ND
(MonoBDE)	-	mg/kg	25	ND	ND	ND
(DiBDE)	-					

			MDL	A4	A5	A6
(OctaBDE)	-	mg/kg	25	ND	ND	ND
(NonaBDE)	-	mg/kg	25	ND	ND	ND
(DecaBDE)	-	mg/kg	25	ND	ND	ND
(2- ) (DEHP)	1000	mg/kg	50	ND	ND	ND
(BBP)	1000	mg/kg	50	ND	ND	ND
(DBP)	1000	mg/kg	50	ND	ND	ND
			50	ND	ND	ND



CANEC24021252902

2024 10 09

5 12

(3) 2021 7 22

DEHP BBP DBP DIBP

ILAC-G8:09/2019

w=0

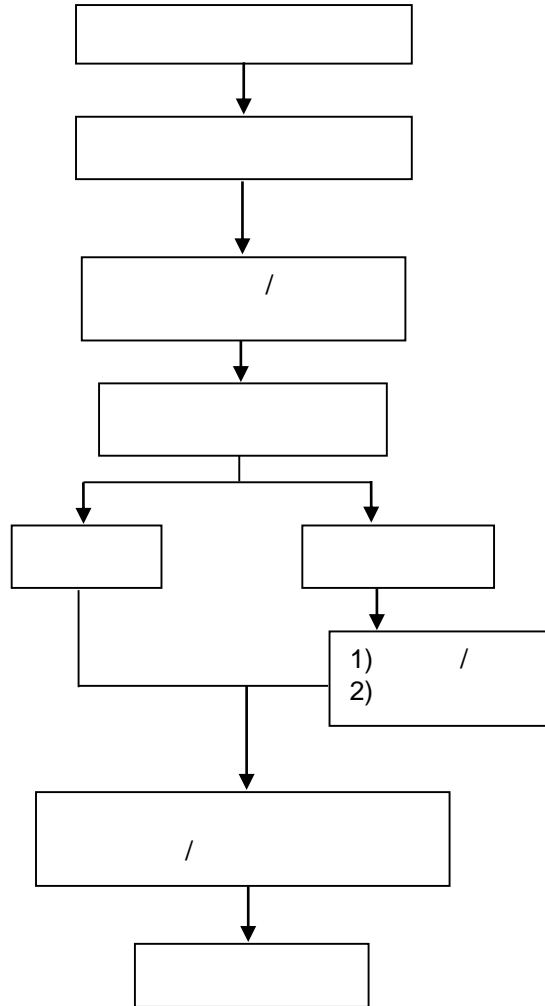

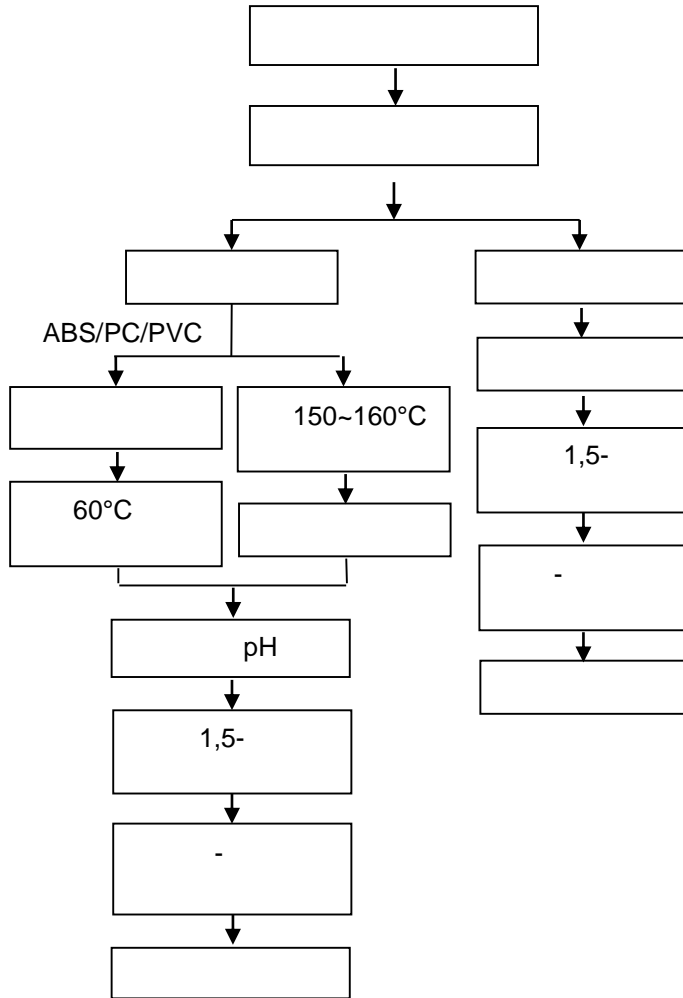

### PBB/PBDE/Phthalates

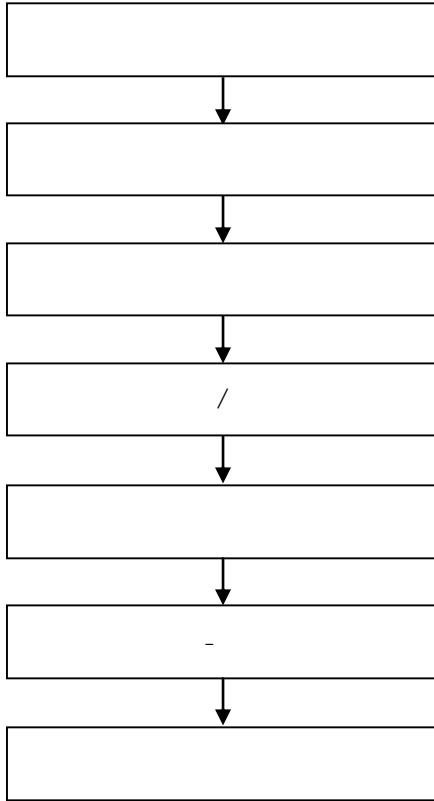



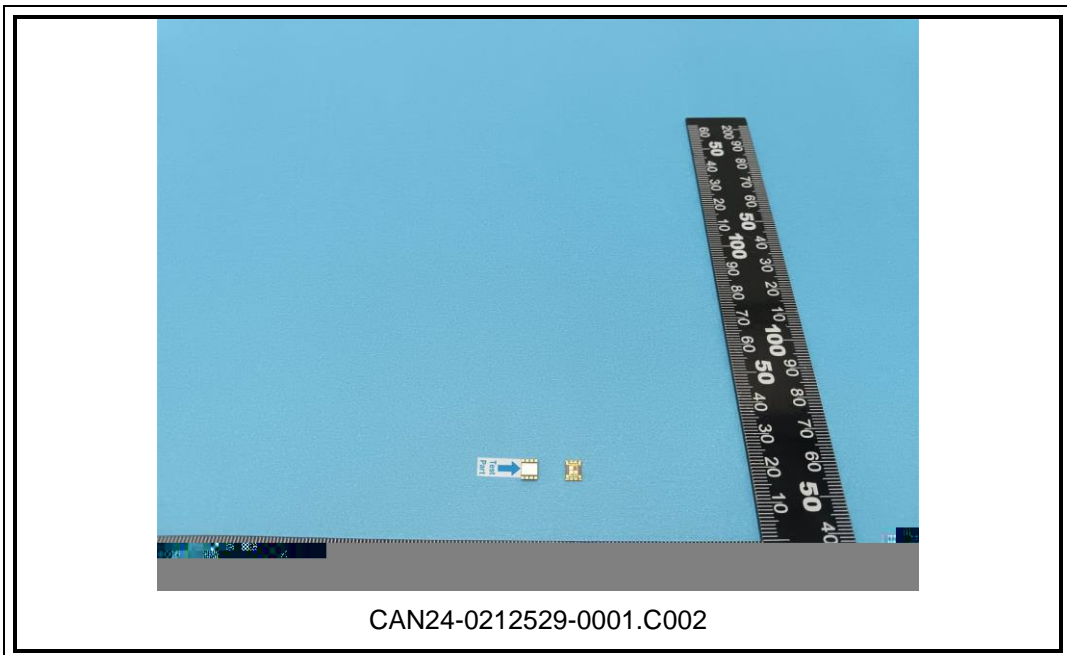

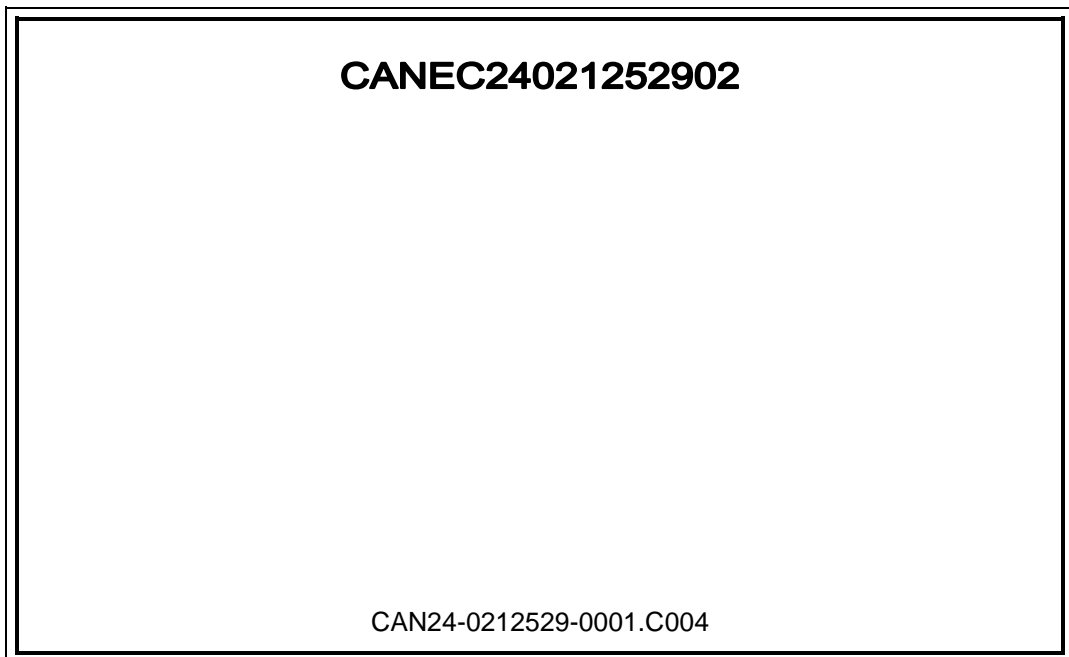
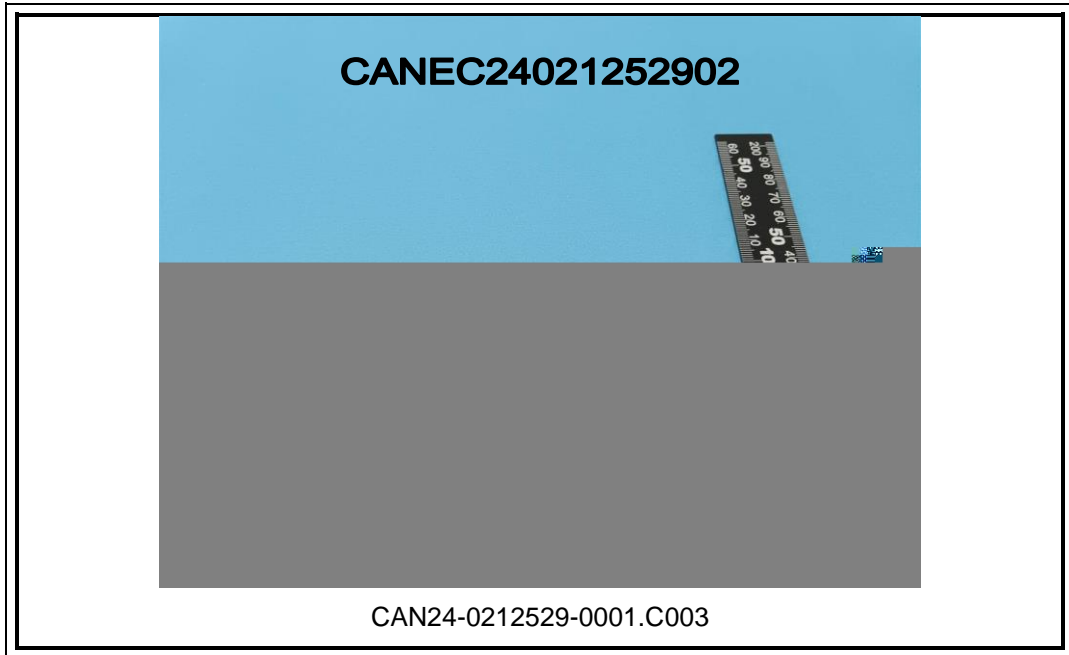

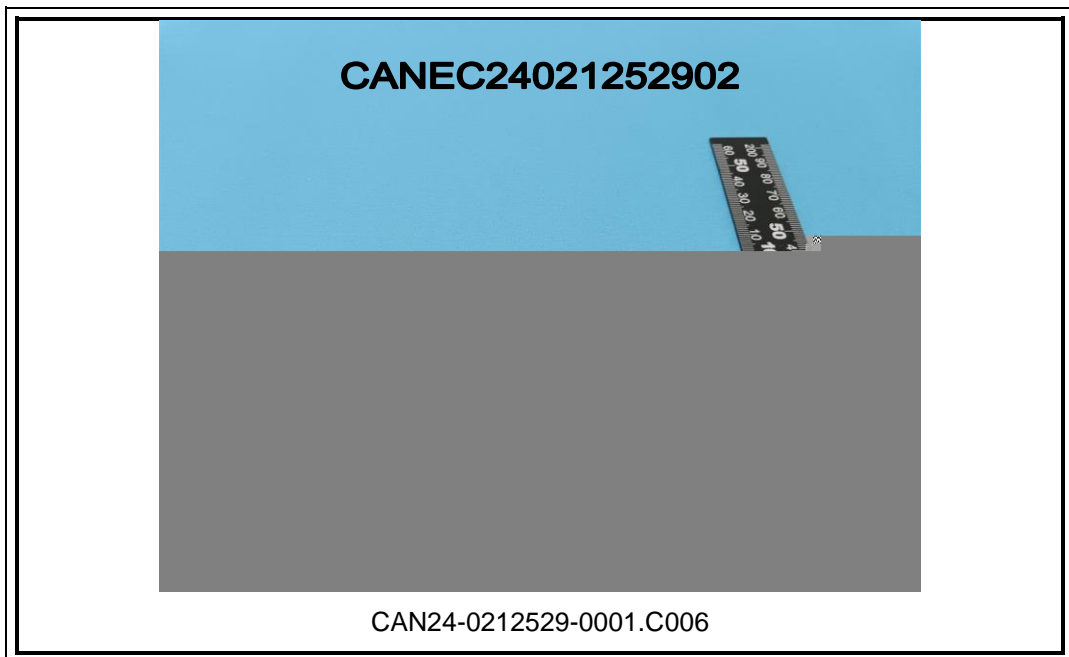
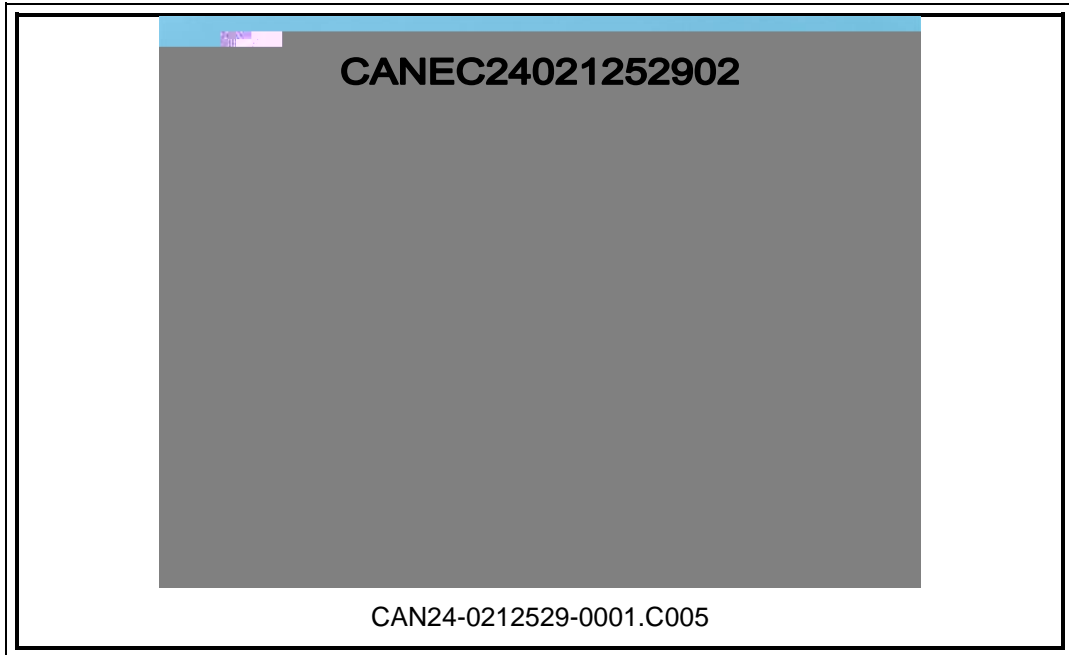

2947

AK

CAN24-0212529-0001.C008

SGS

\*\*\*

\*\*\*